

NOTICE DE MONTAGE

ASSEMBLING
INSTRUCTIONS
03.05.2020 rev 0

SINKI XXL



15 min



x2

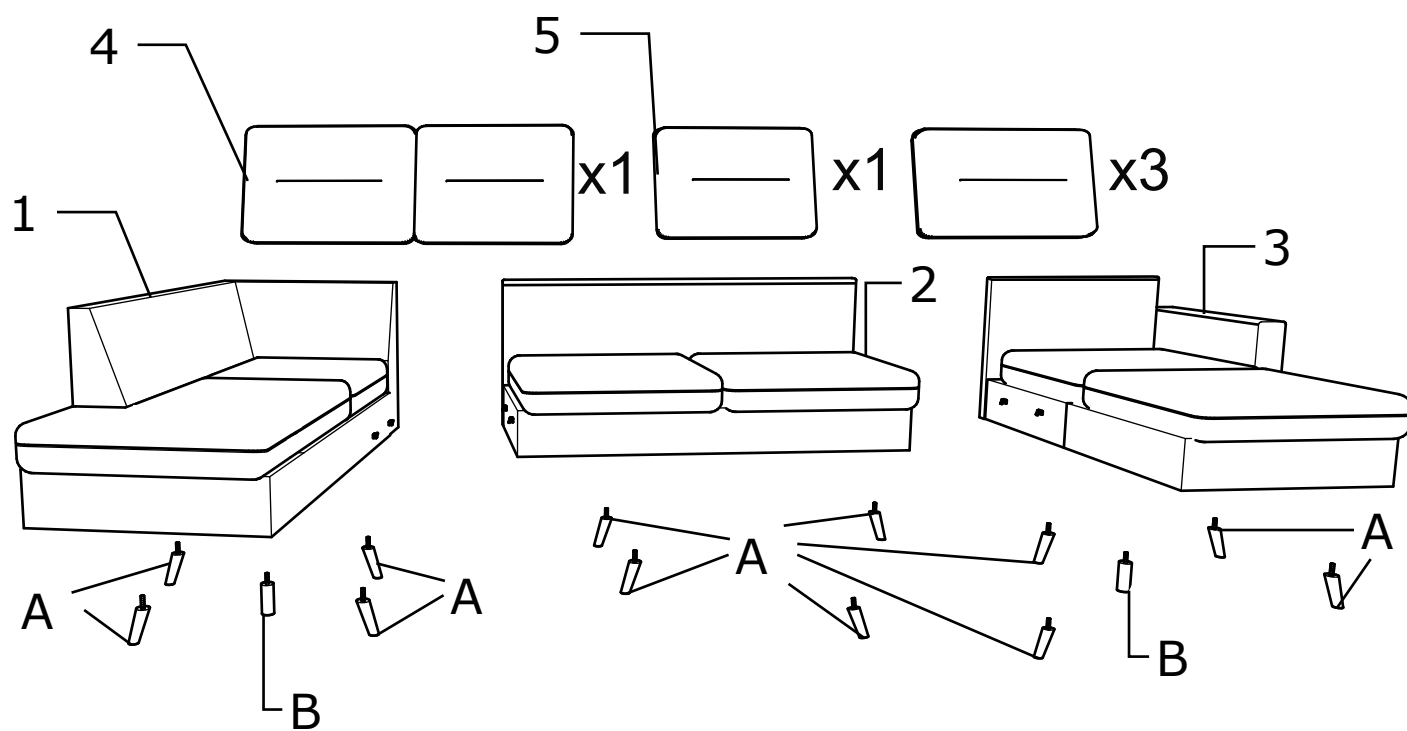
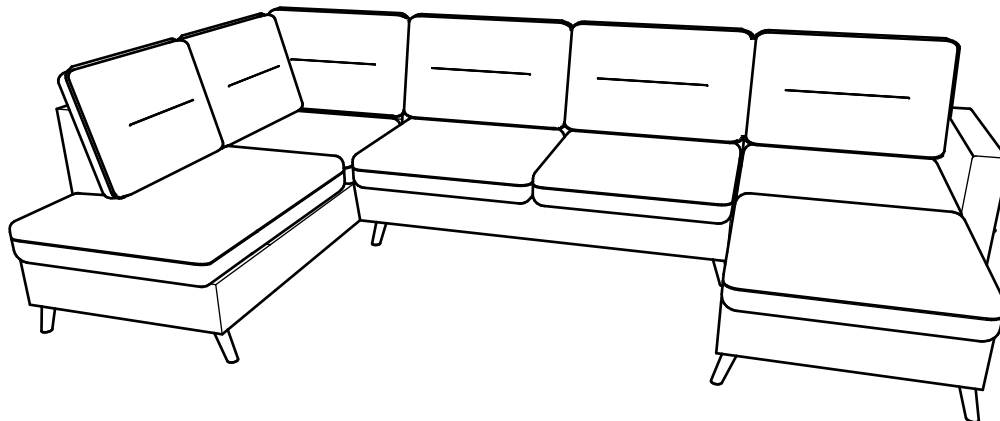

A x12

B x2



1

R

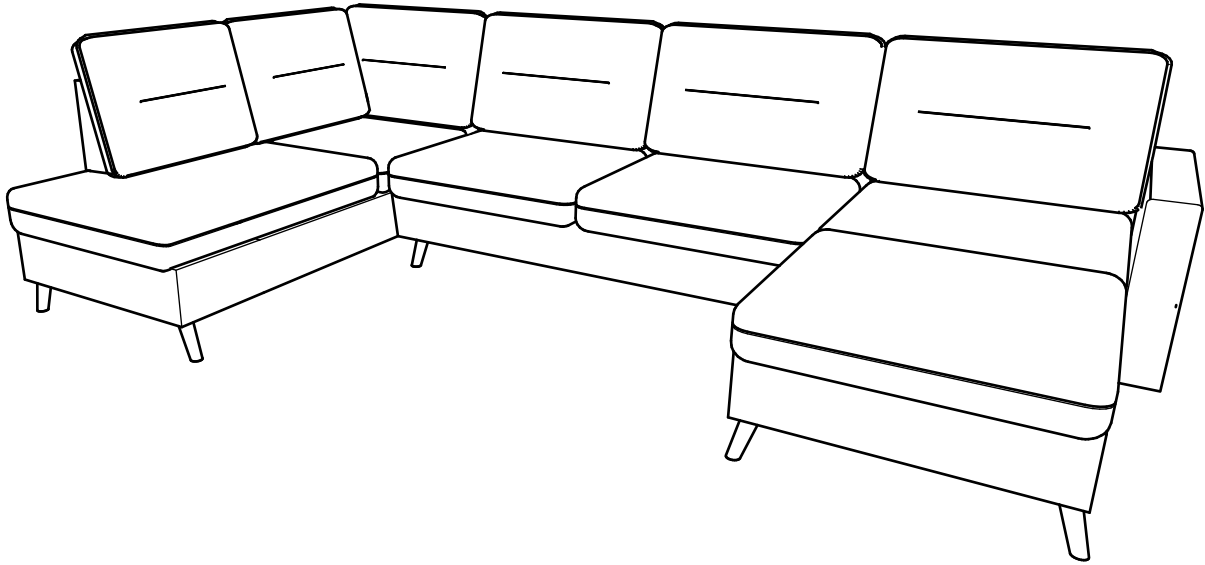

L

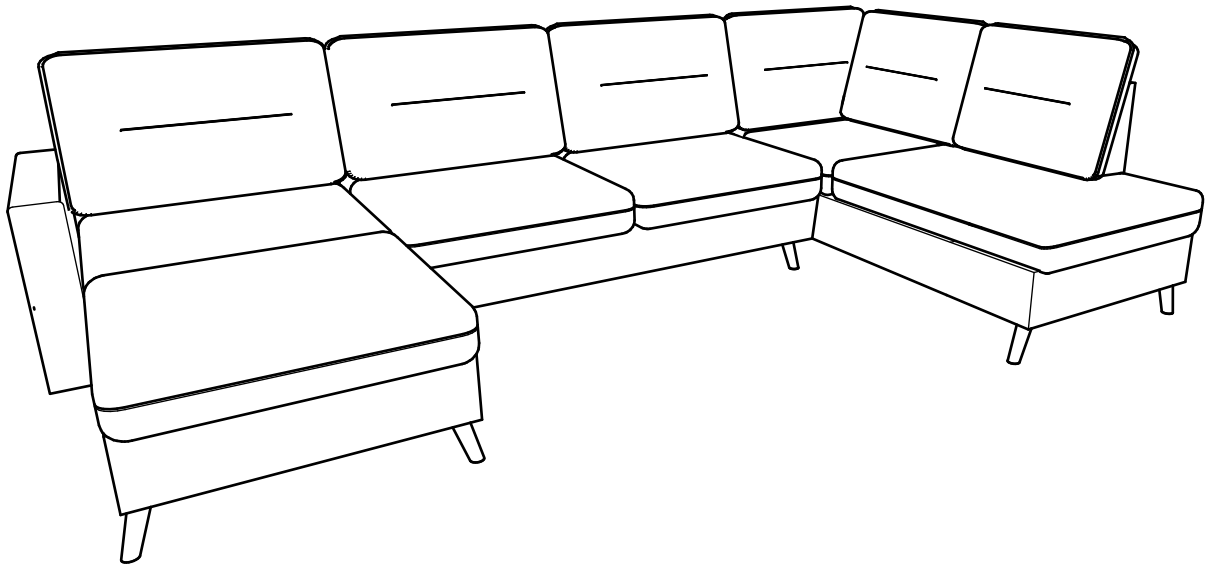

2

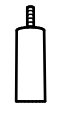
	
A x4	B x1

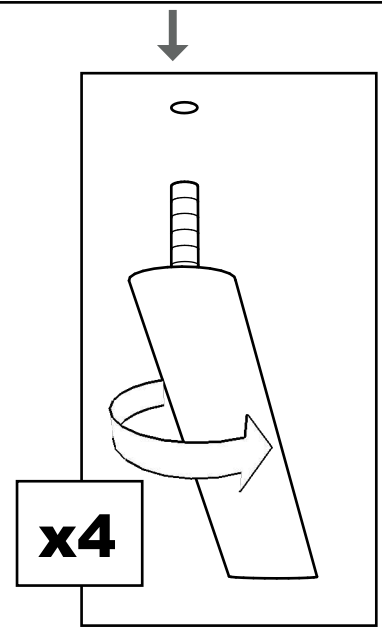
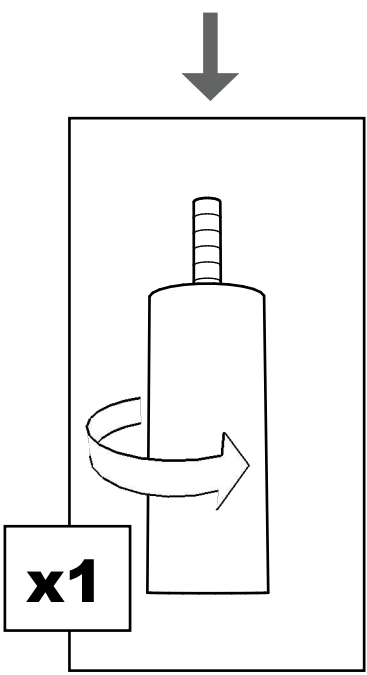
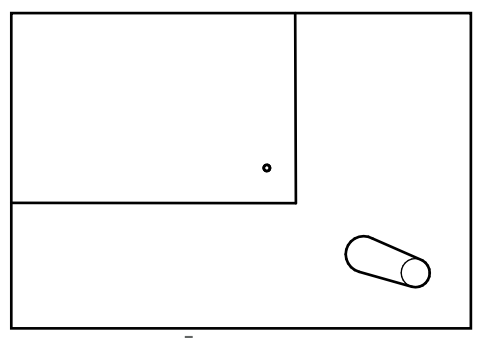
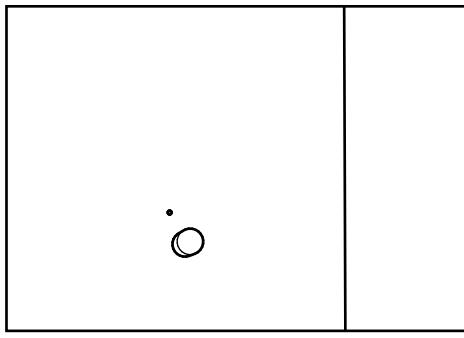
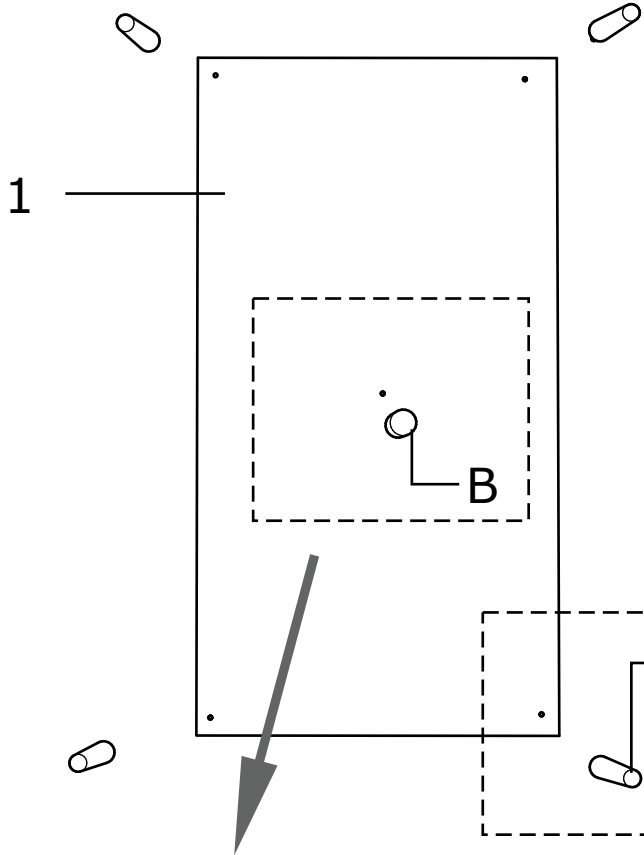

3



A x4

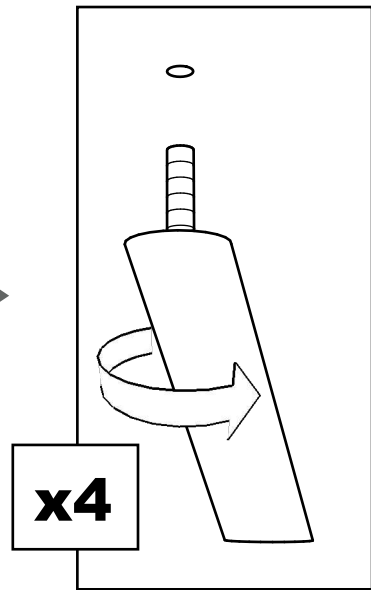
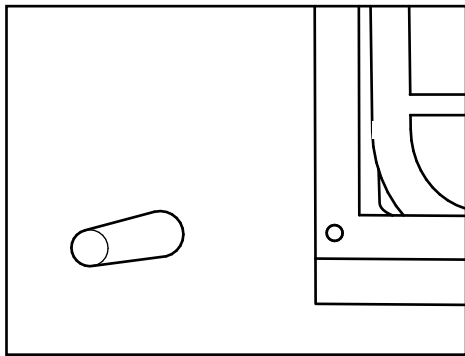
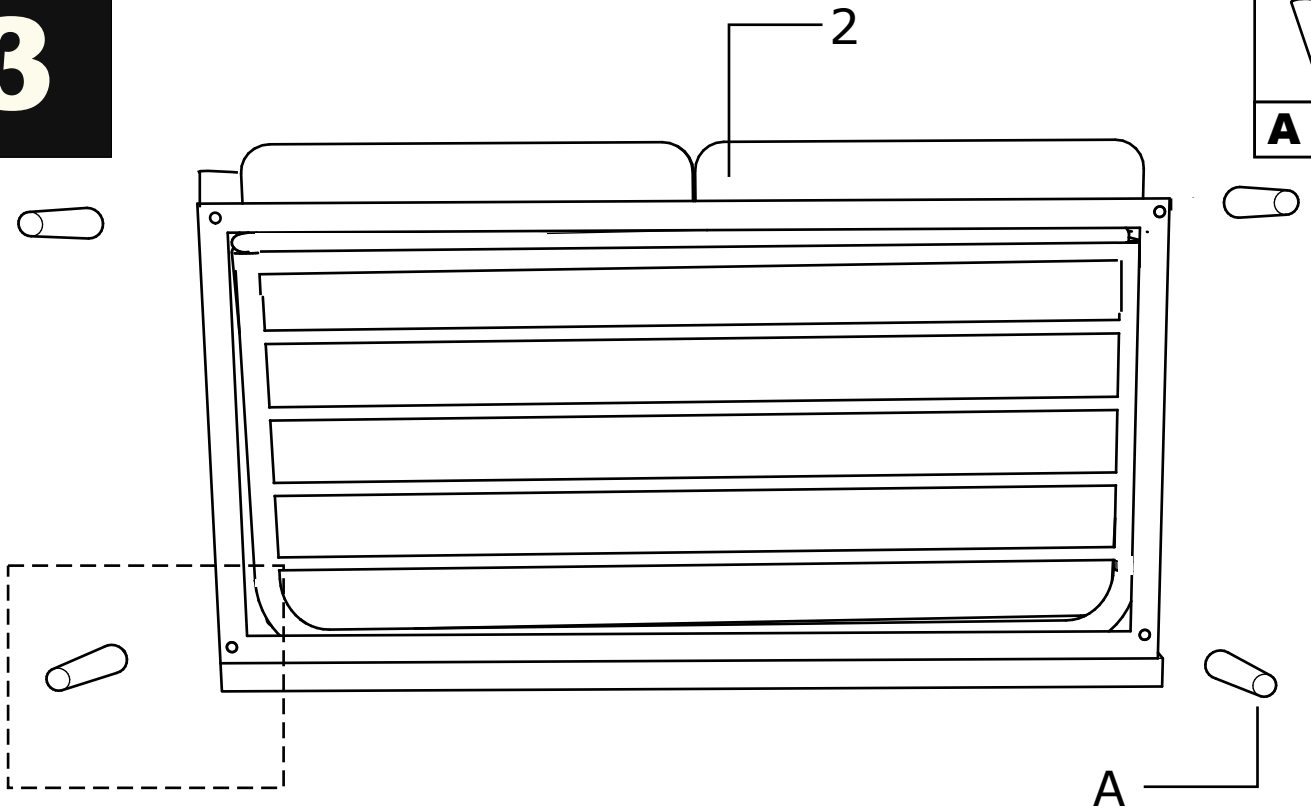

4

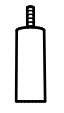
	
A x4	B x1

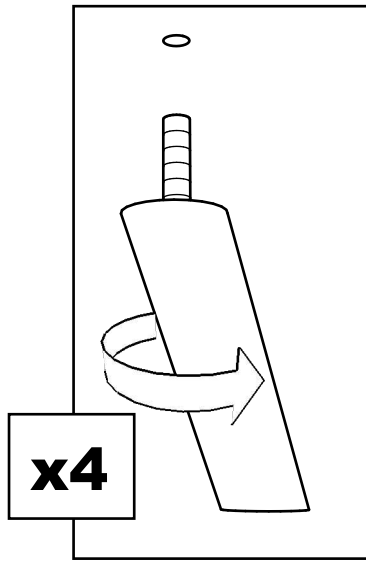
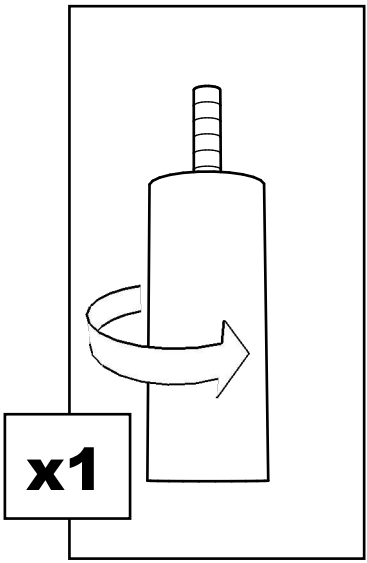
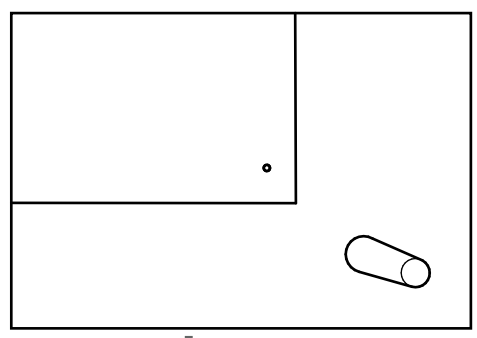
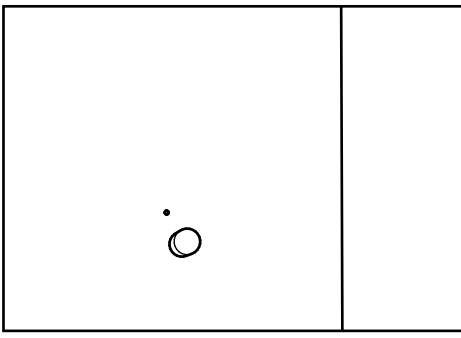
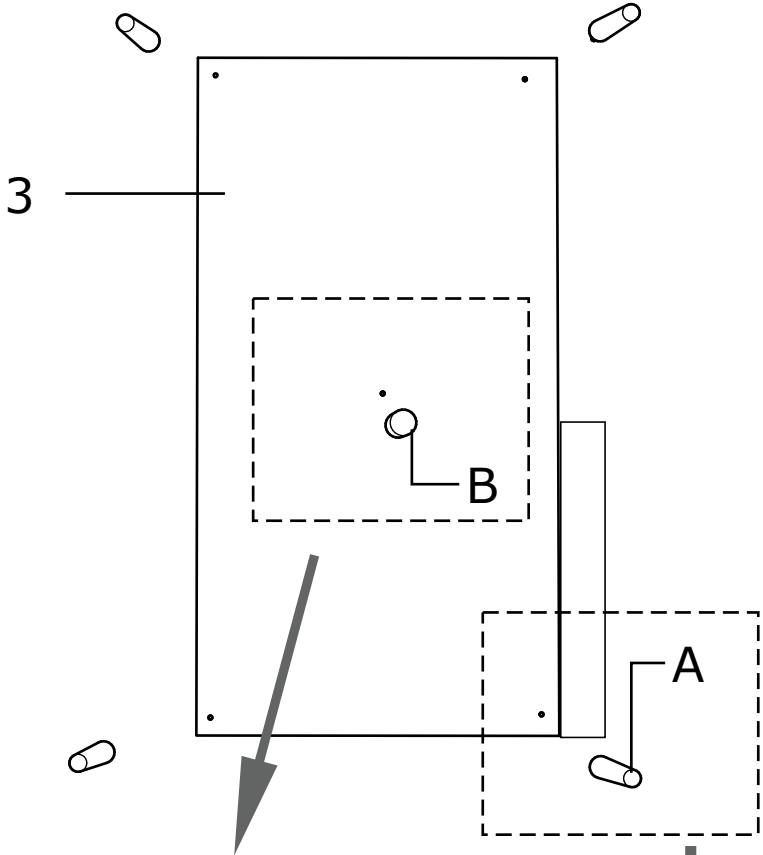

5

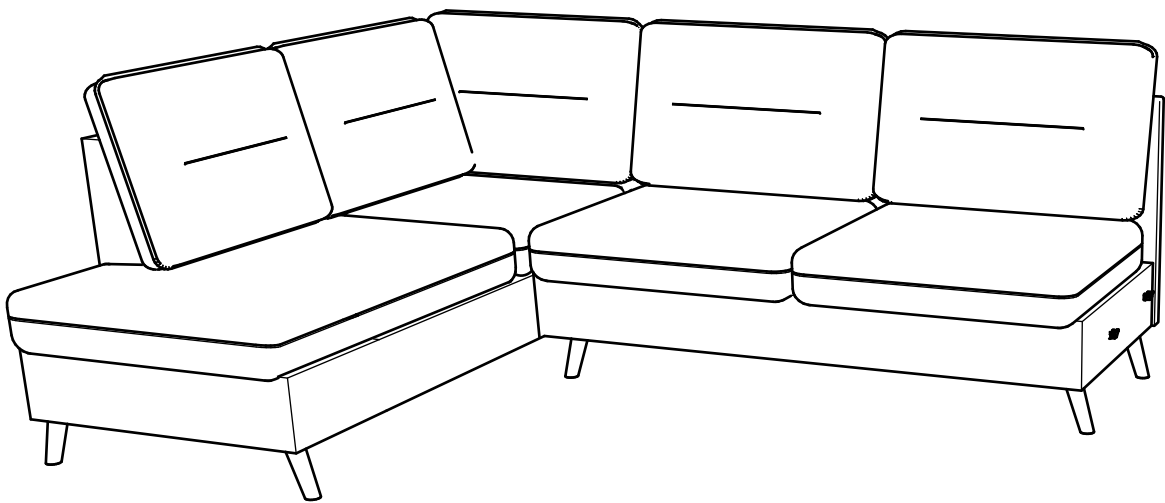
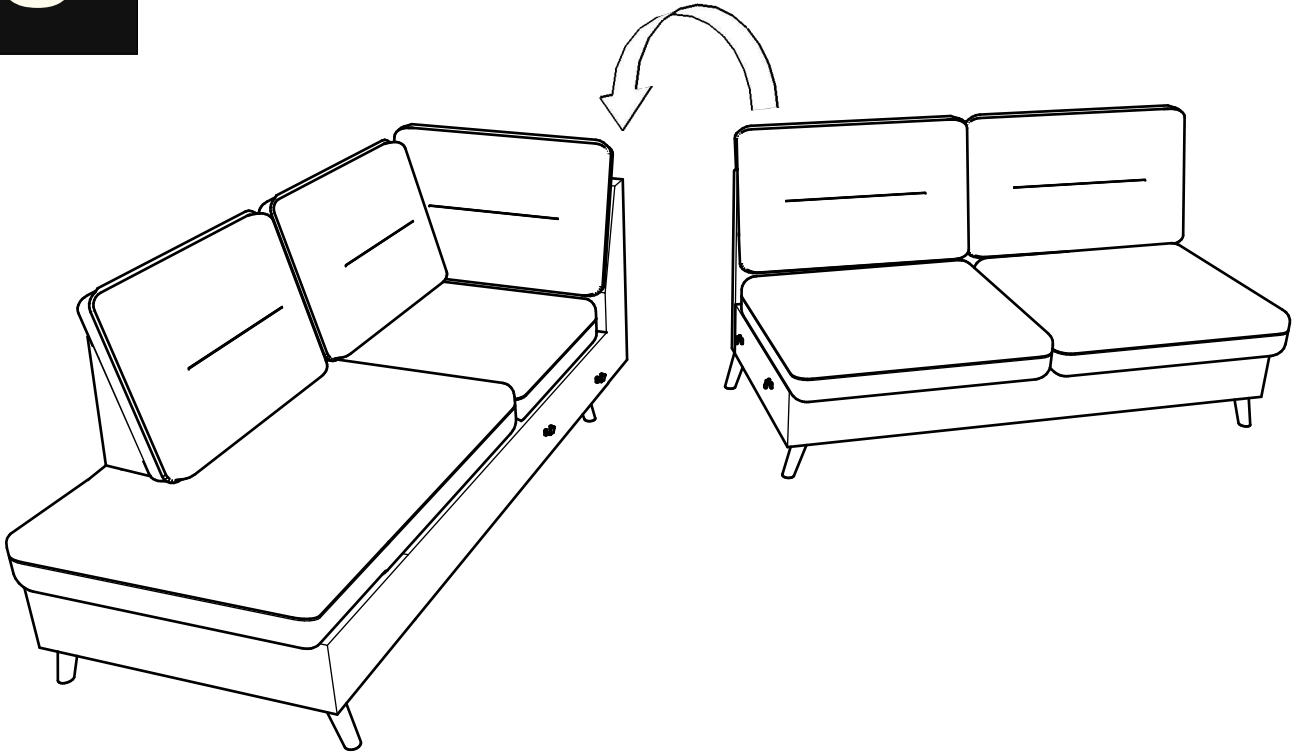

6

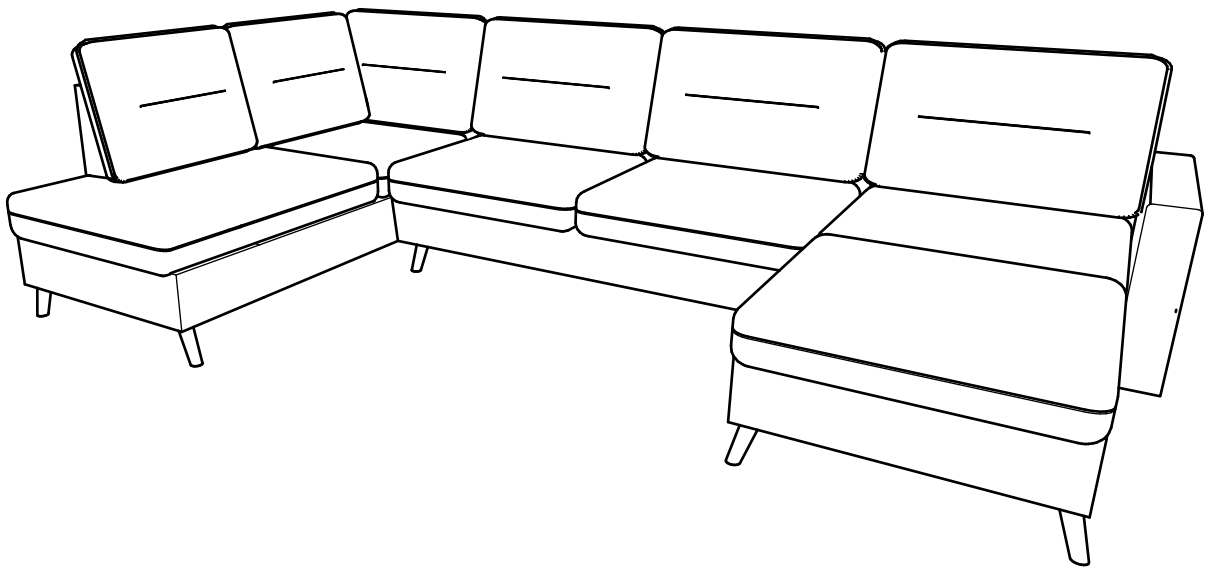
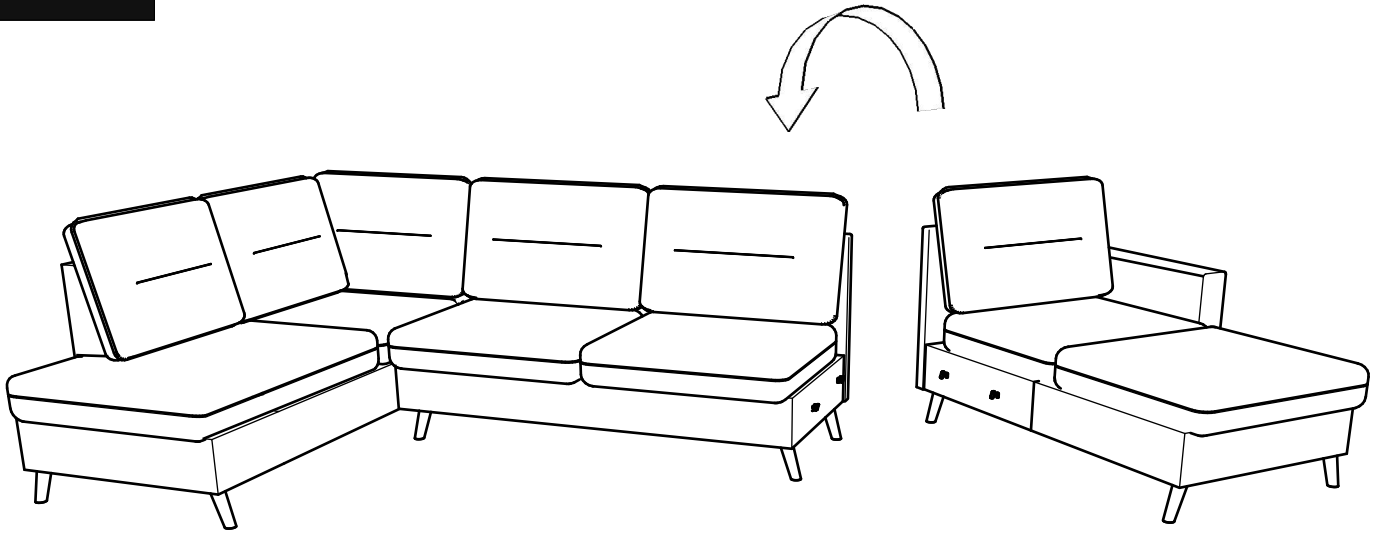

7

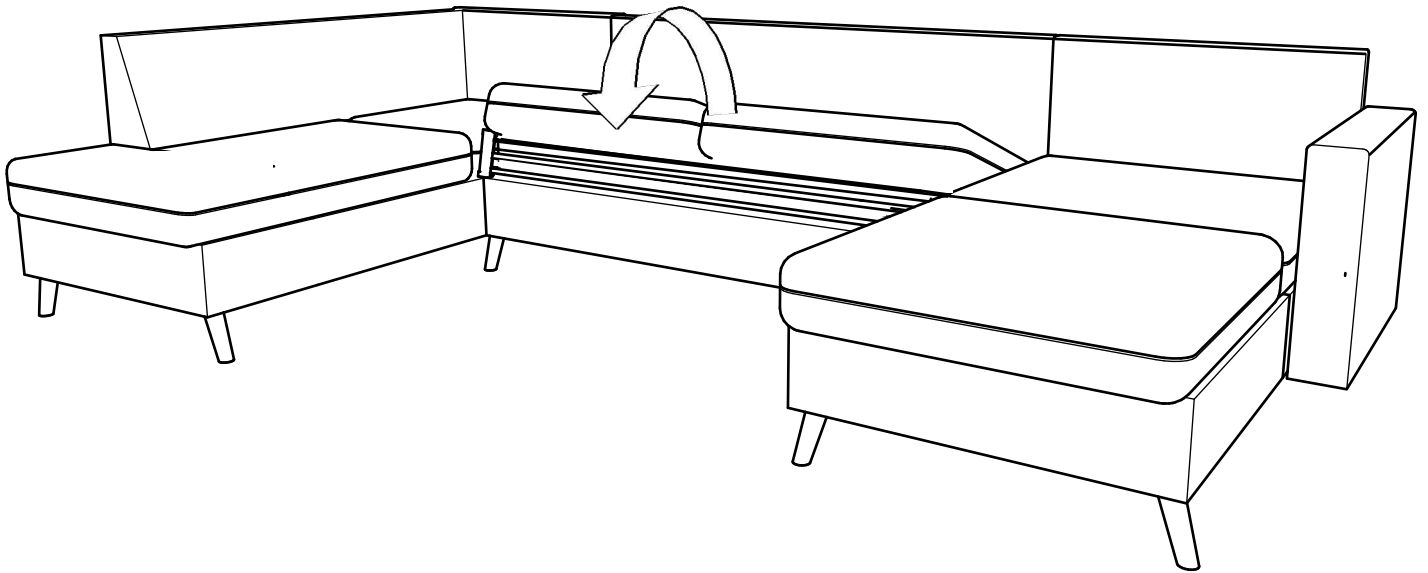
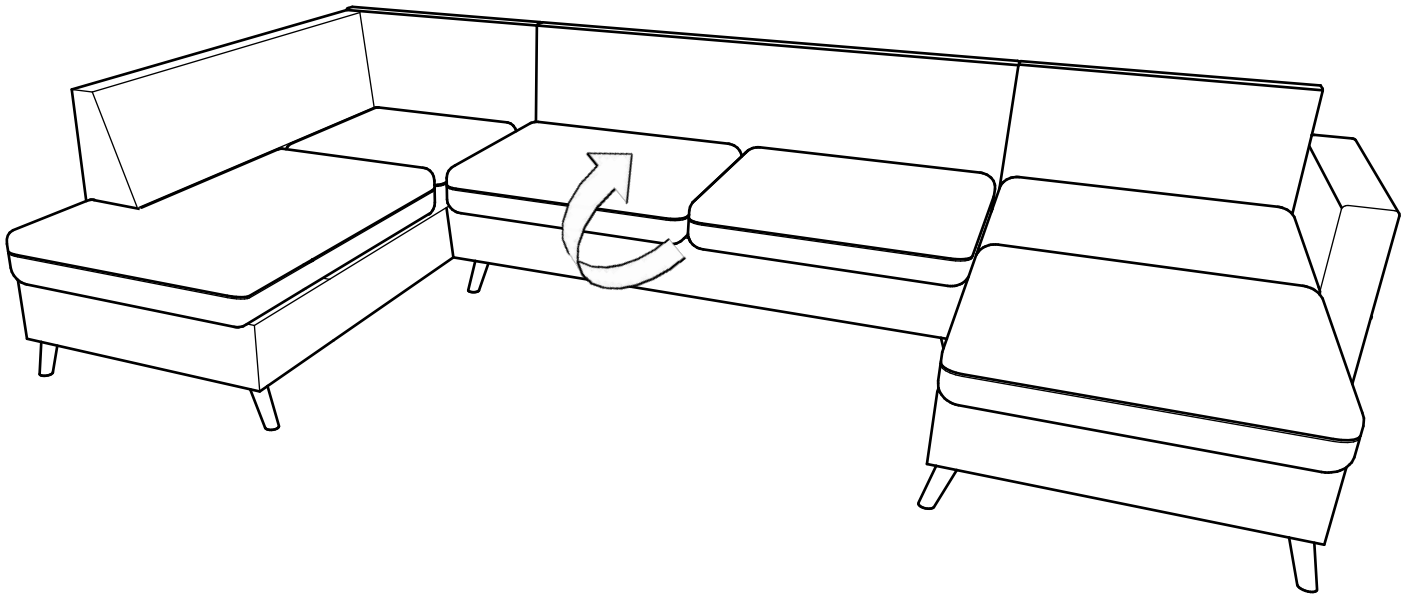

8

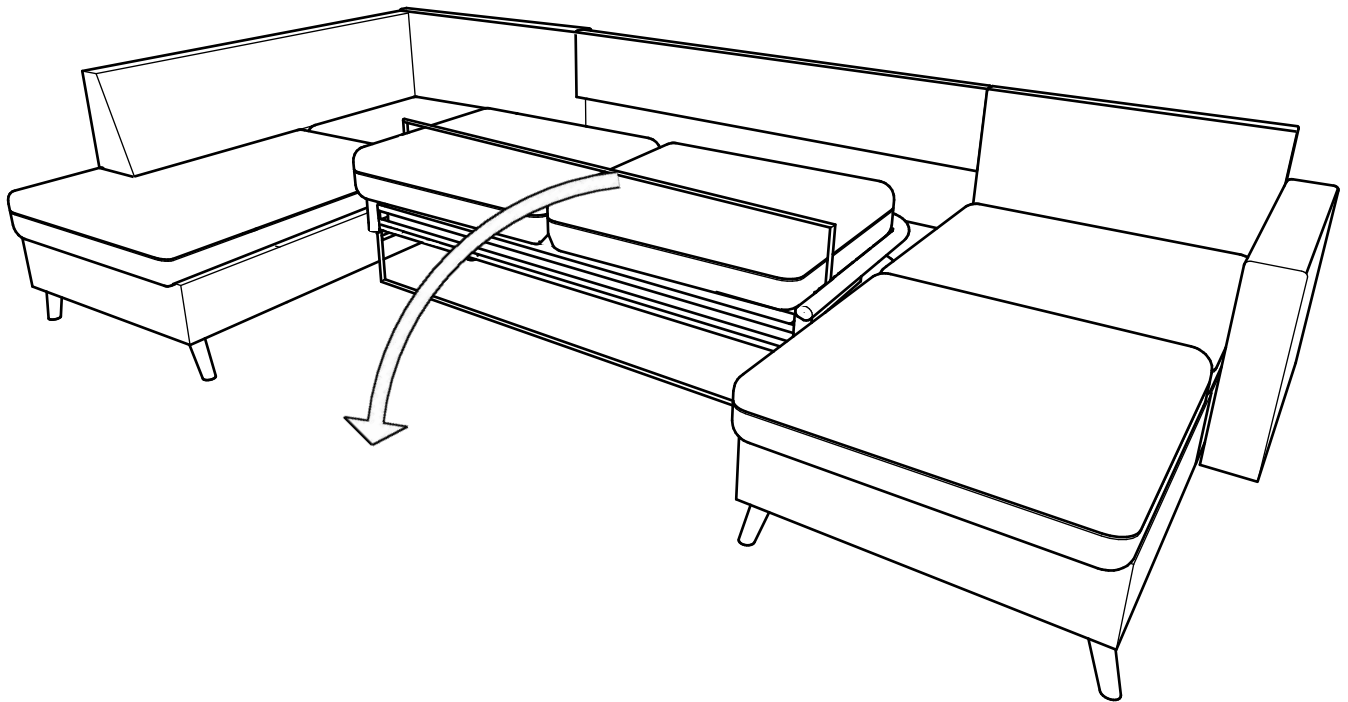
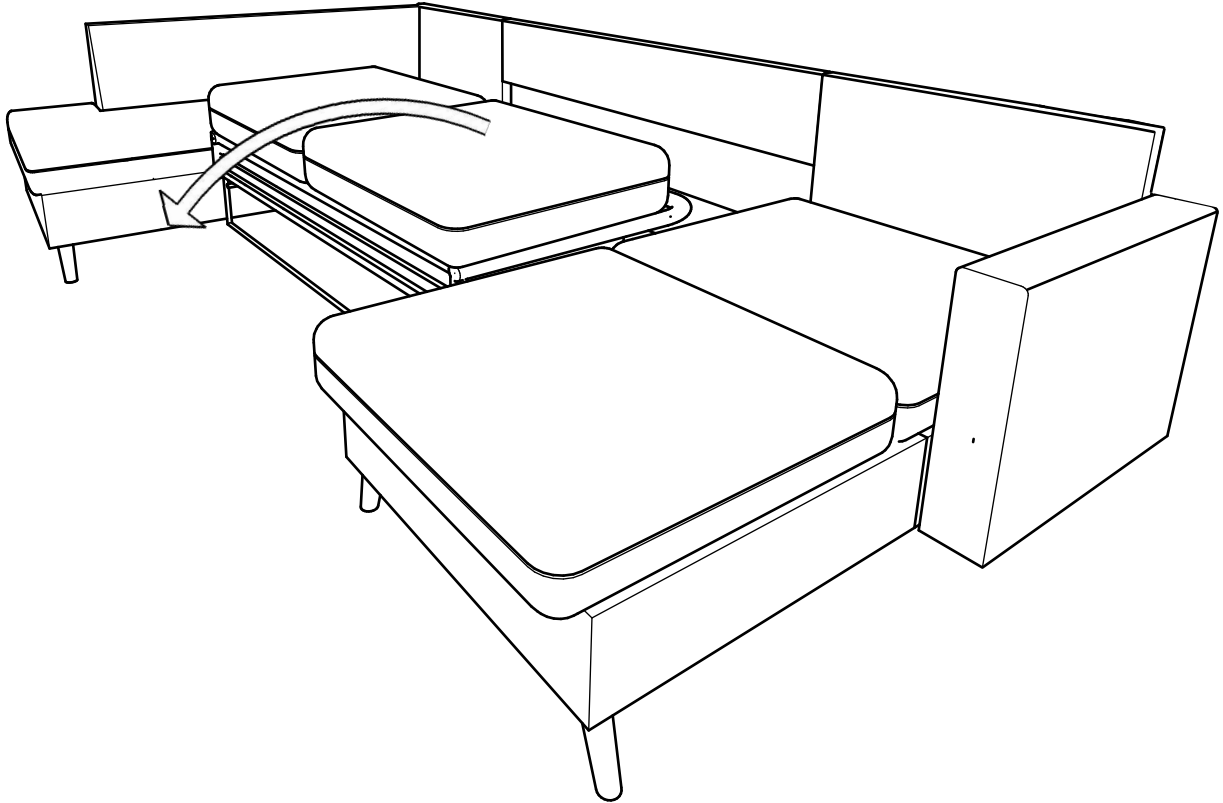

9

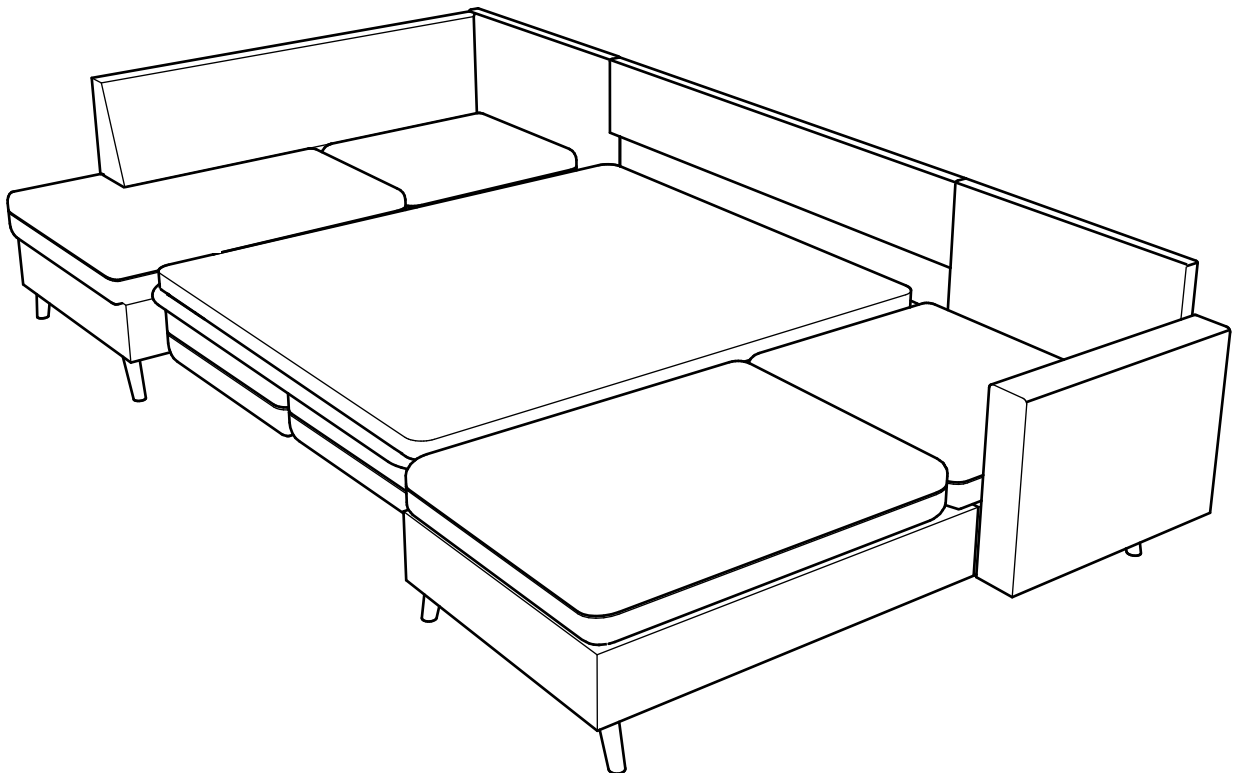
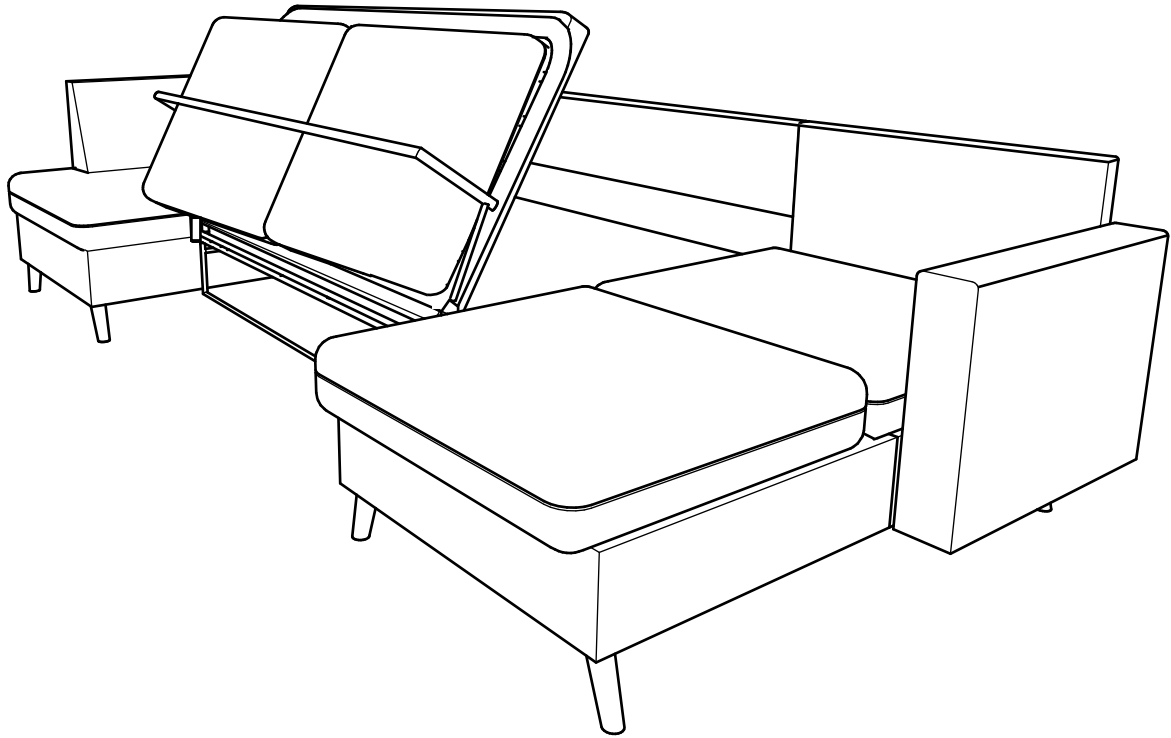

10

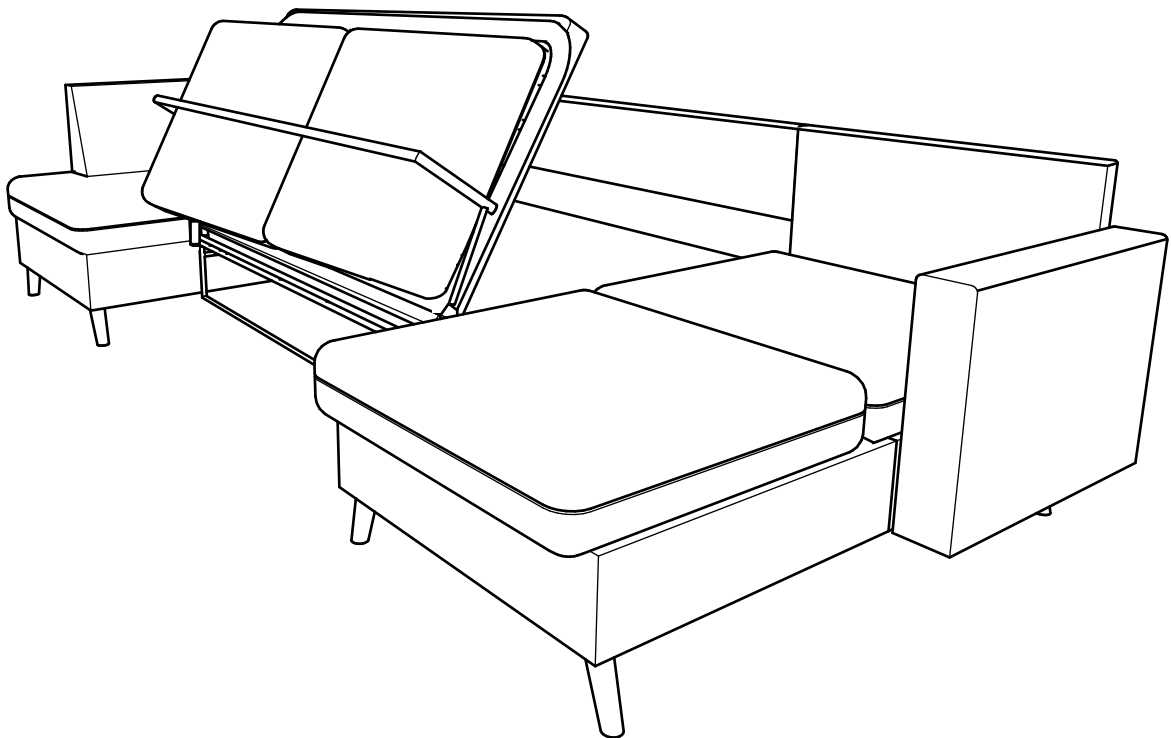
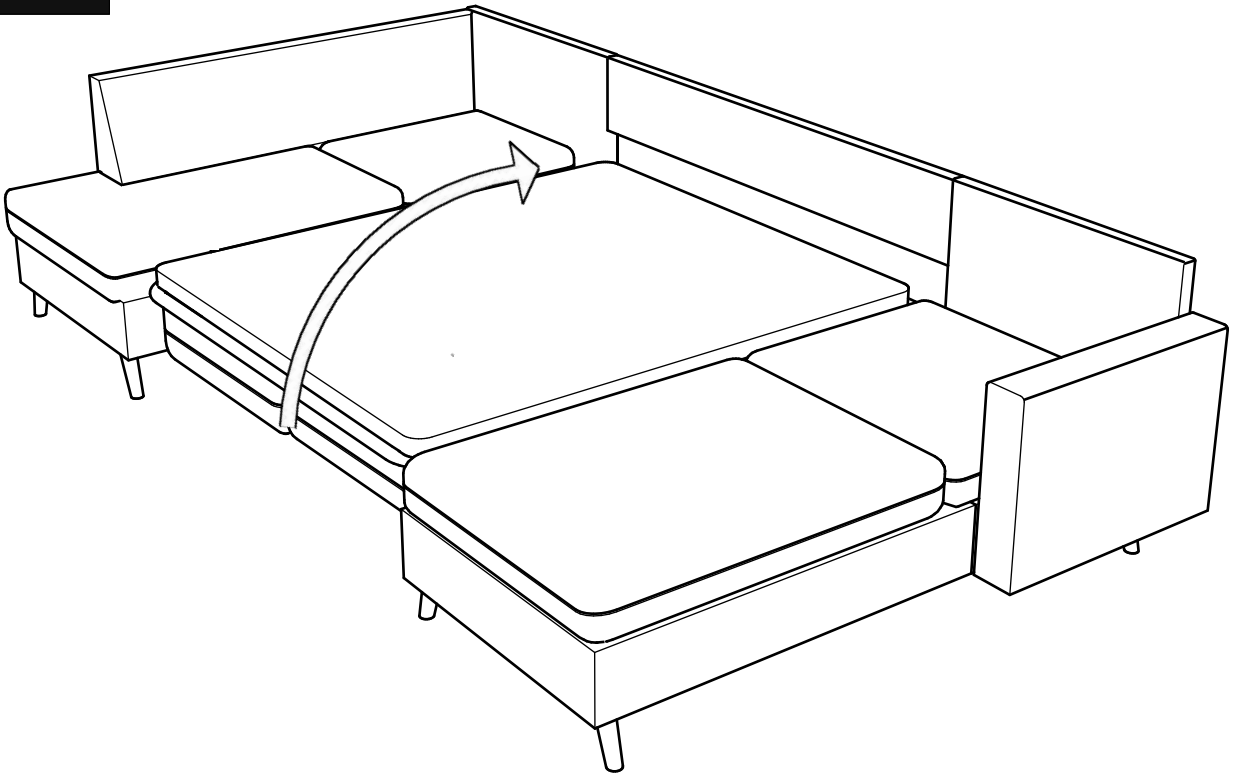

12

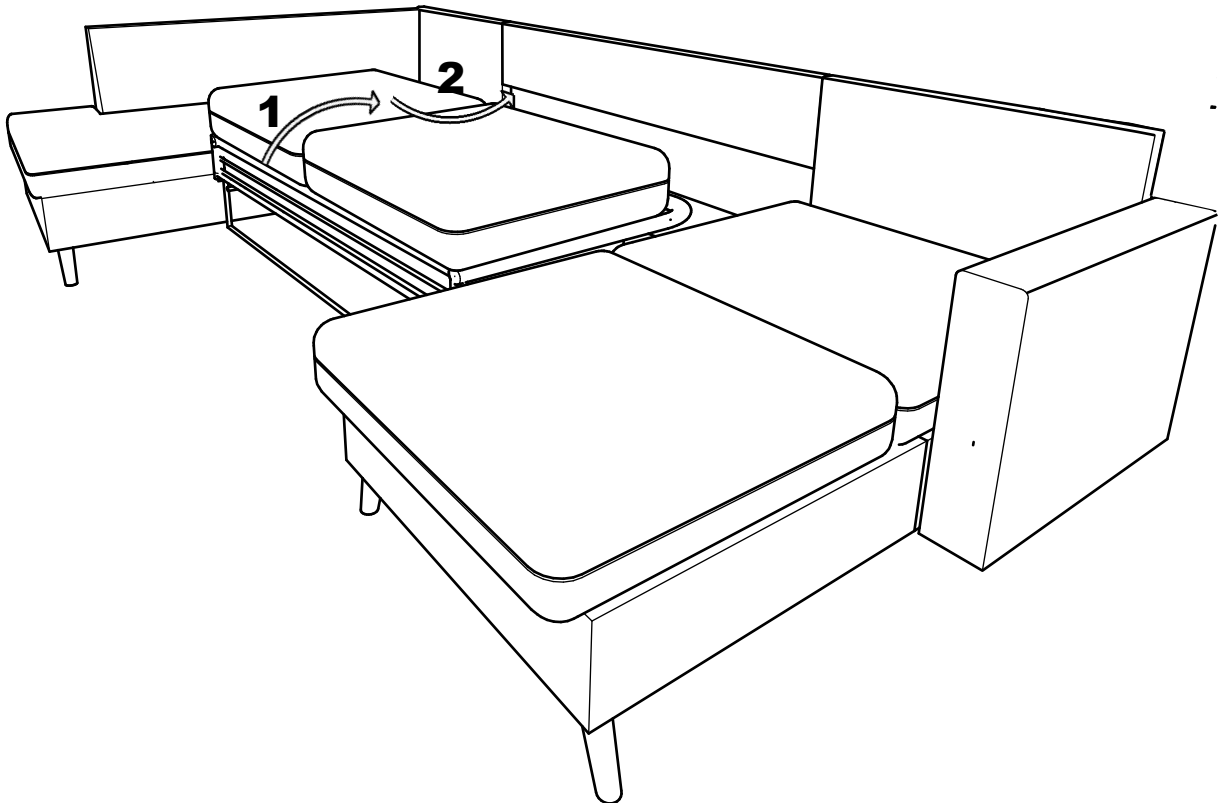
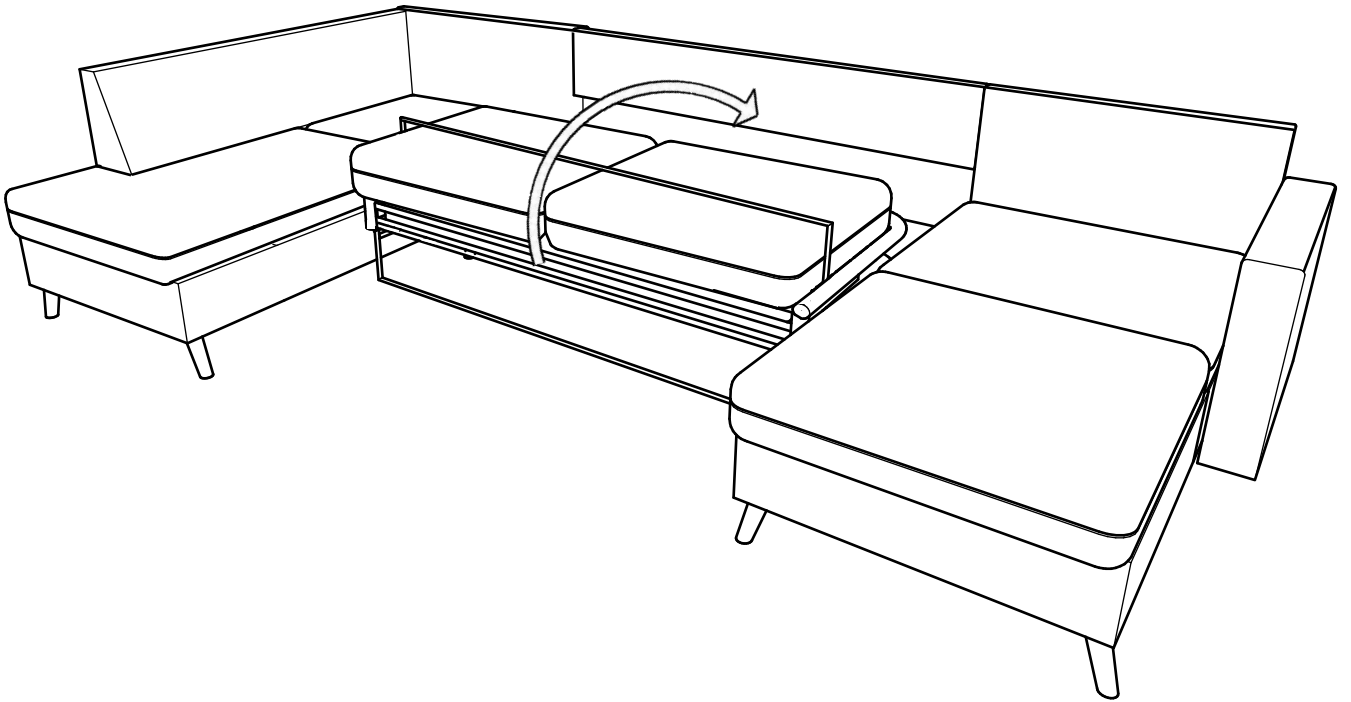

13

