

**VOLTAIRE**

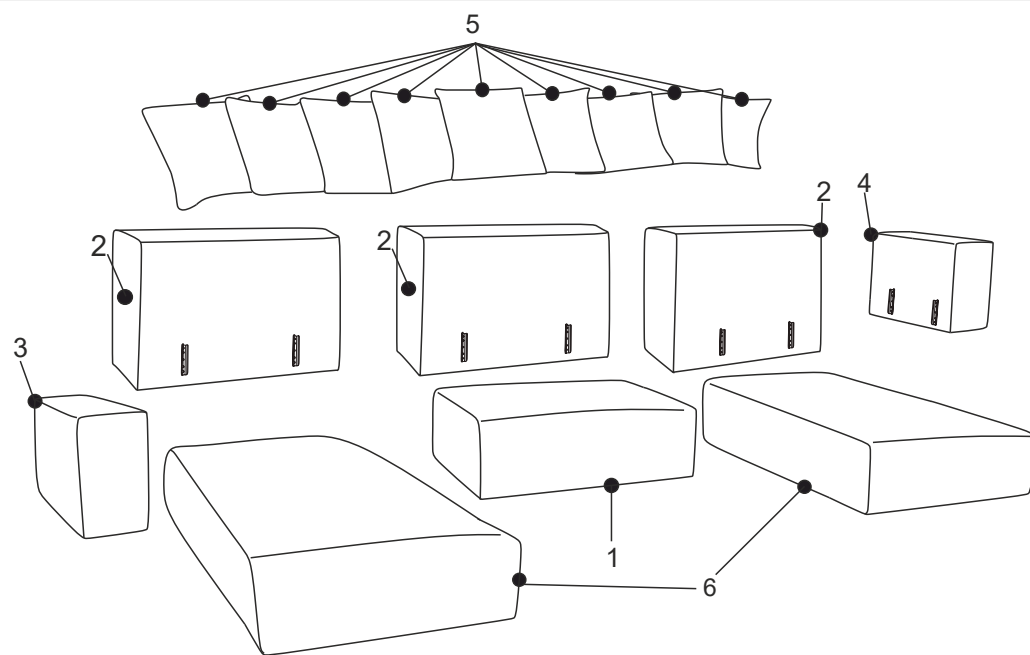

**A x 4**

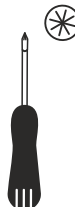
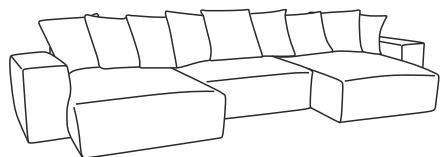

**B x 8**



**C x 8**  
6 x 35

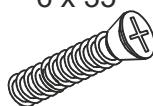

**D x 16**  
6 x 20



**I**

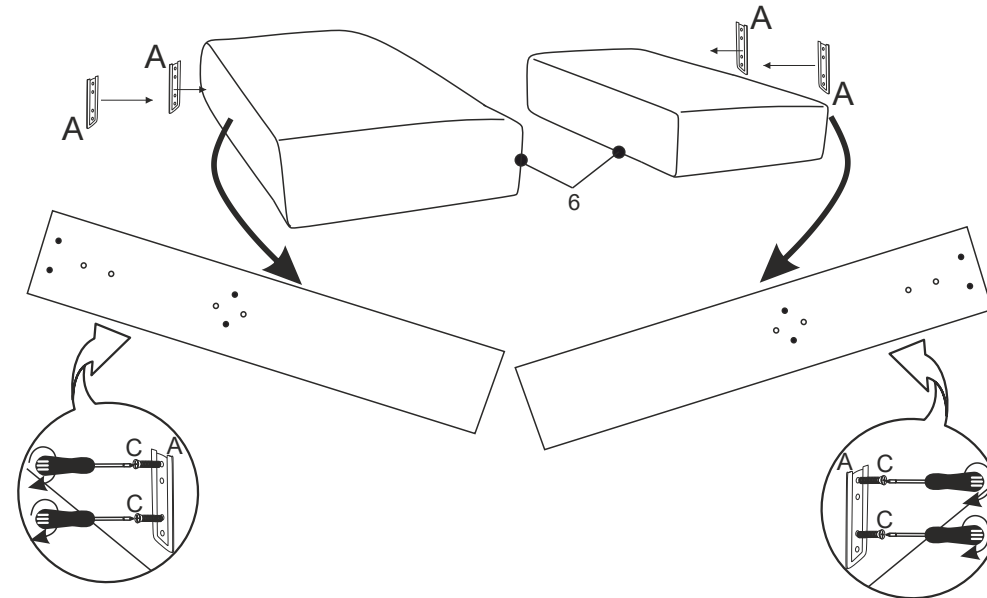
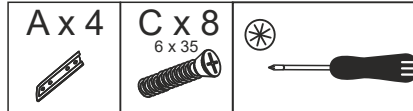

**II**

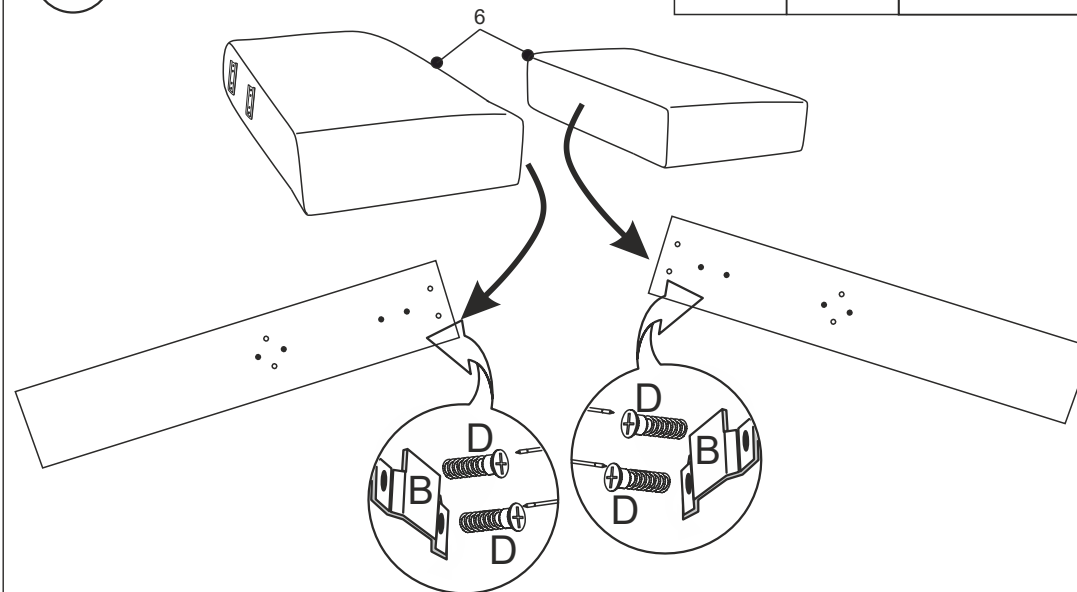
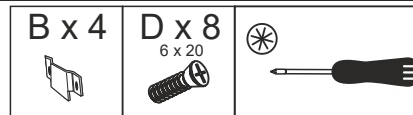

III

B x 4    D x 8  
6 x 20

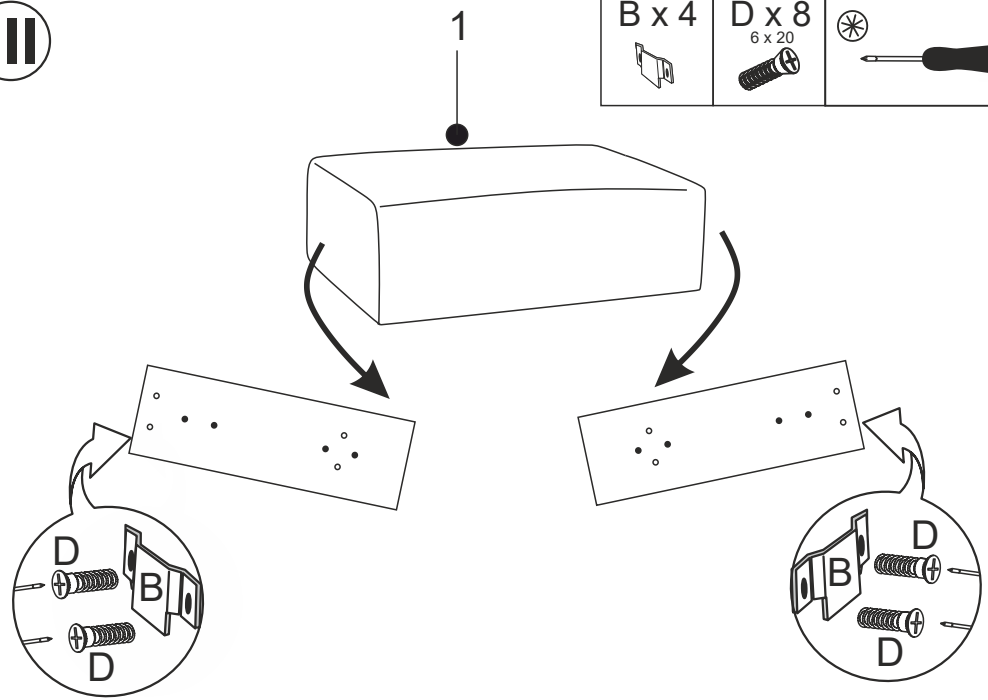
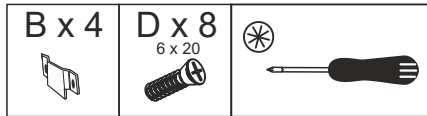

IV

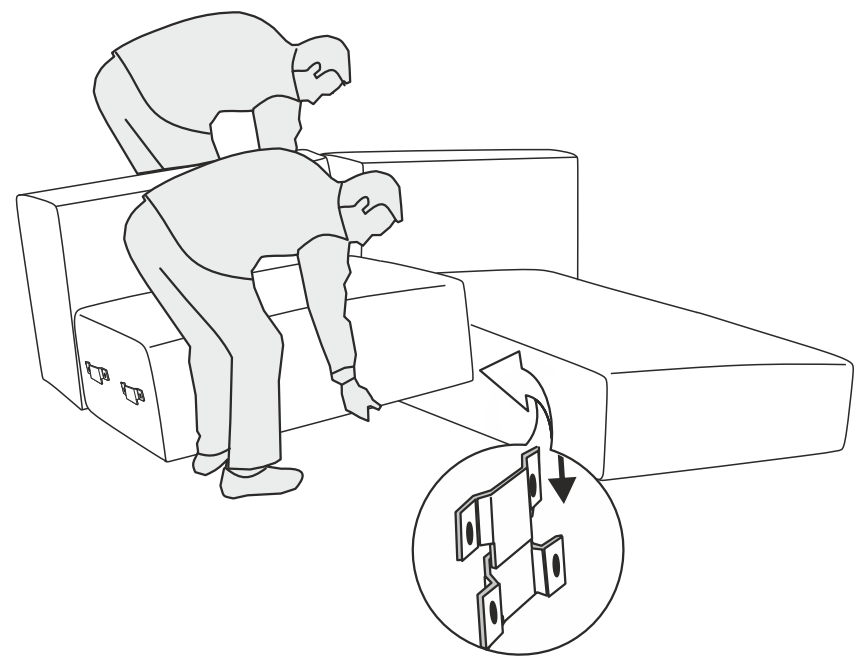

IV

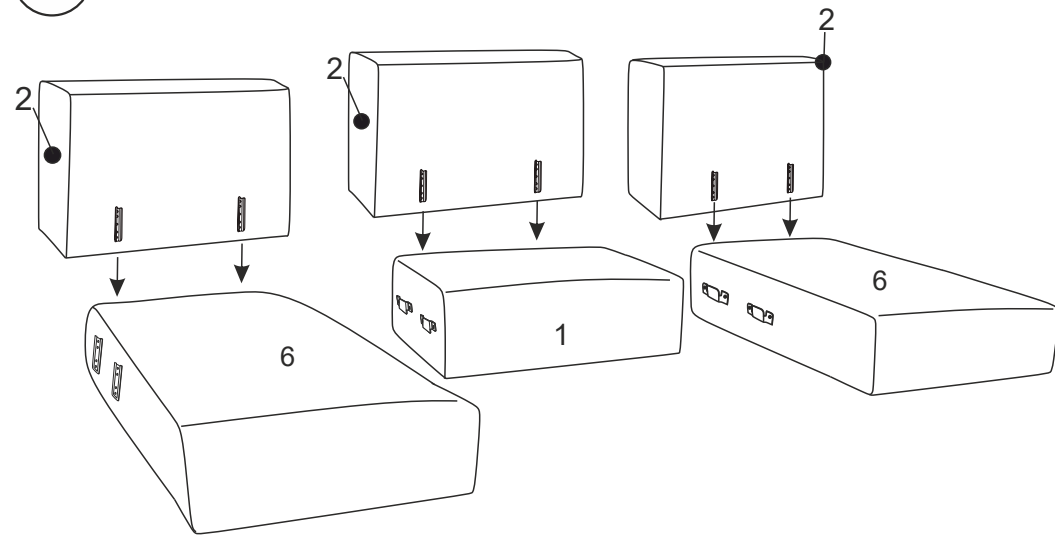

V

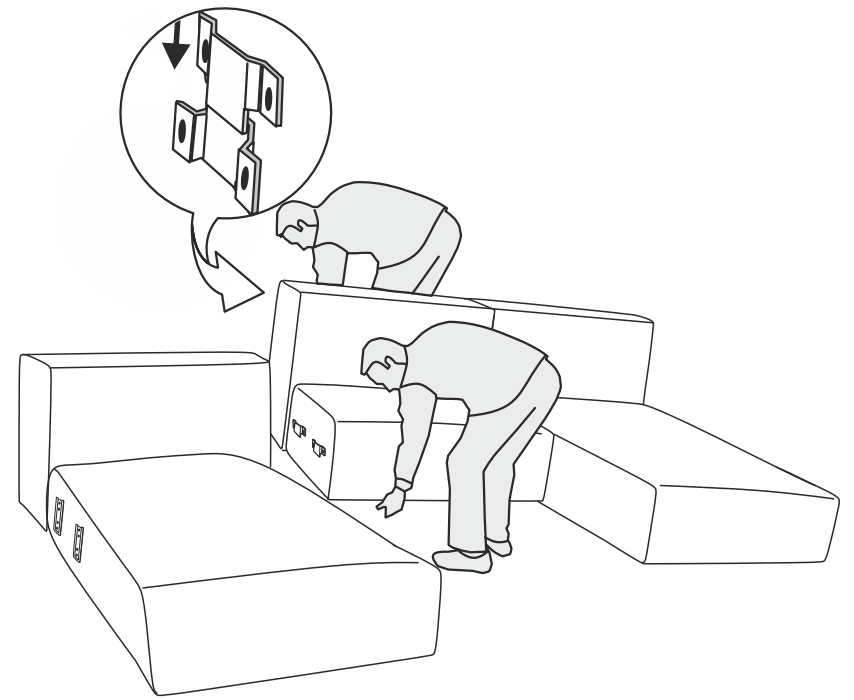

VI

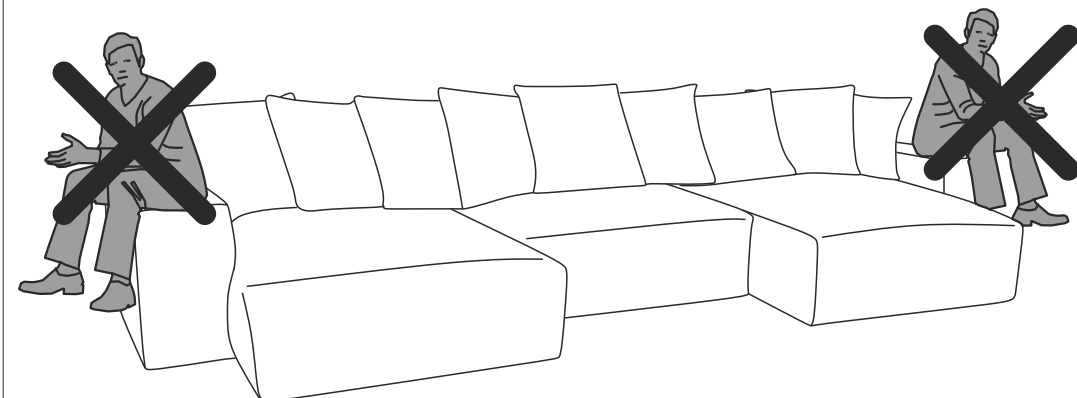
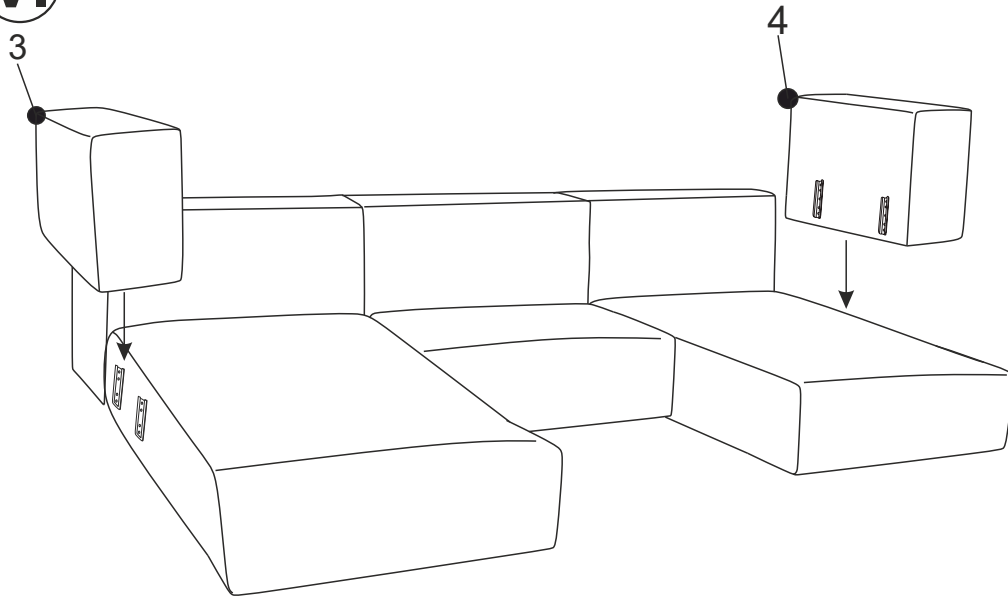

VII

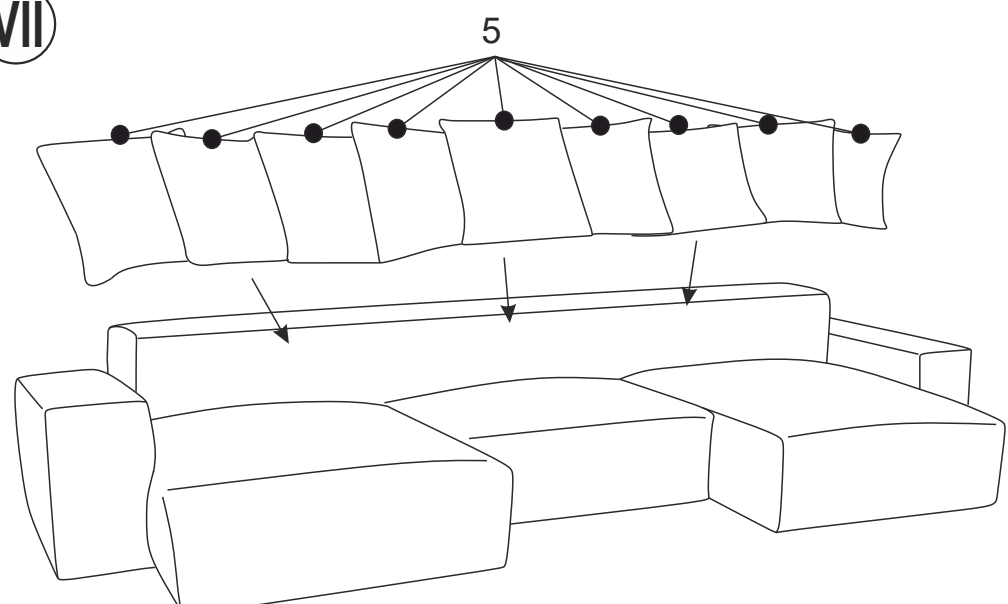

Remarque : les bosses, la déformation du siège, les concavités du coussin du siège ne sont pas un défaut et ne font pas l'objet d'une réclamation. Ce sont les caractéristiques des oreillers remplis de silicone et sont une caractéristique distinctive de ce produit.

Note: Dents, déformations of the seat, concavities of the seat are not a defect and are not subject to complaint. These are the characteristics of silicone-filled pillows and are the distinguishing features of this product.