

ENVY 2 PLACES

NOTICE DE MONTAGE
ASSEMBLING INSTRUCTIONS



30 MIN



x2

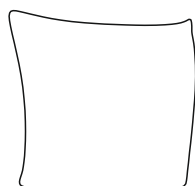
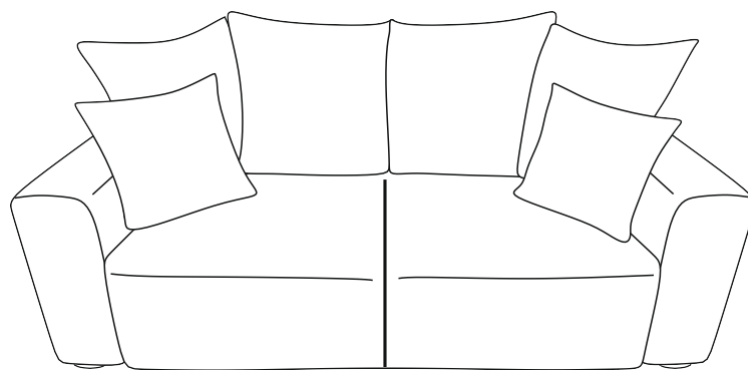

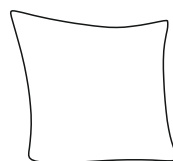

D x4

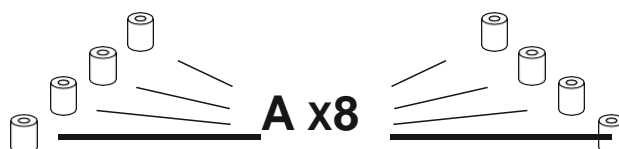
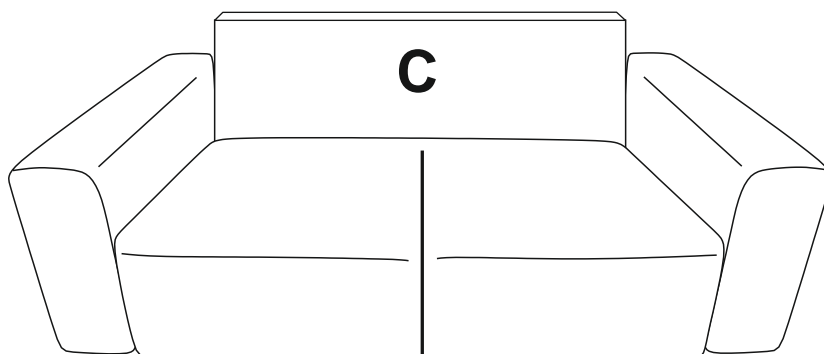

E x2





A x8

			
A	x8	B	x8

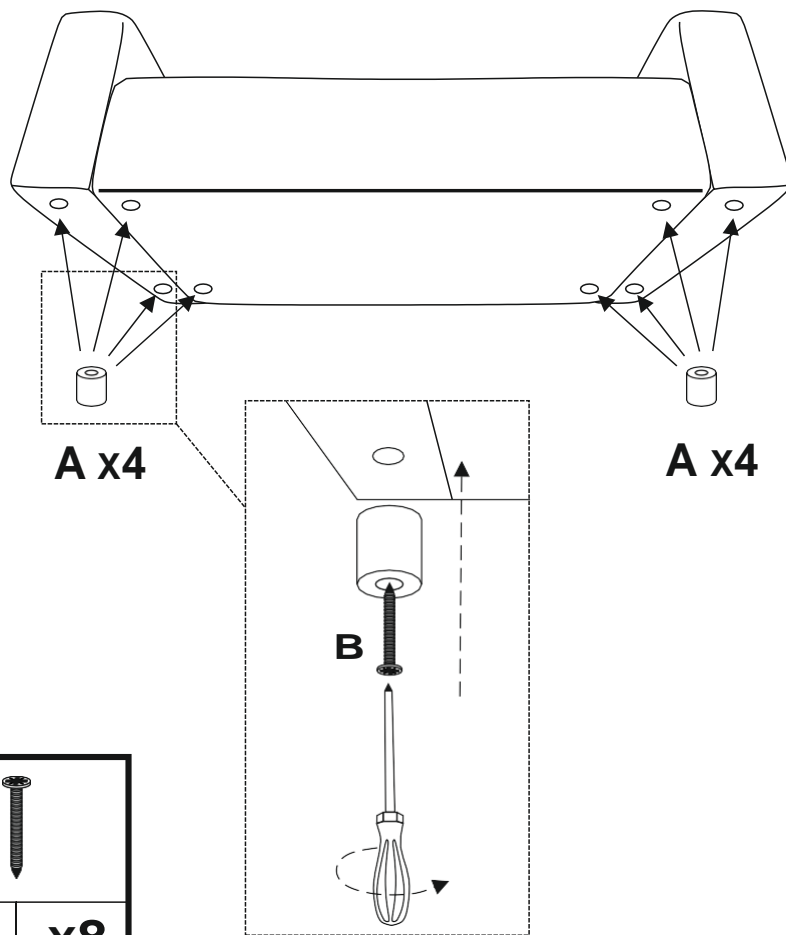
1

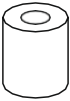

			
A	x8	B	x8

2

